

Graber® Measuring Guide for Roller Shades and Solar Shades

Tools and Tips

- Steel tape measure — do not use cloth tape
- Pencil
- Measure each window and identify window locations – size variances are common
- Round measurements to the nearest 1/8"
- Clearly record measurements – width vs. height

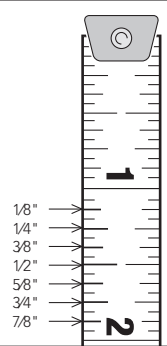

Choose a Mount Type: Inside Mount or Outside Mount

(See next page if you need help deciding which mount is best for your windows.)

Inside Mount Window treatments are installed inside the window casing.

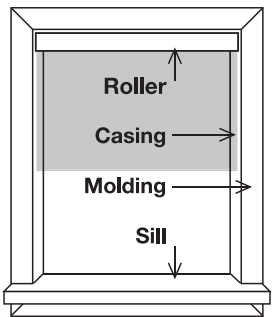

Inside Mount Blind

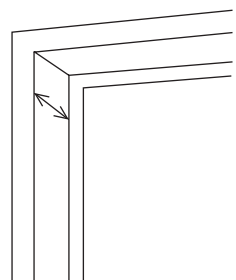

Depth

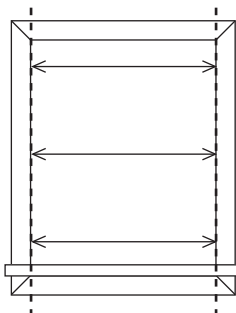

Width

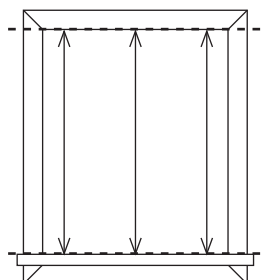

Height

- 1 **Measure Depth:** See chart on next page to determine if window casing has enough depth for an inside-mount window treatment.
- 2 **Measure Width:** Measure the inside width of window casing in three places. Record narrowest measurement.
- 3 **Measure Height:** Measure the inside height from the top of window casing to top of sill in three places. Record longest measurement.

Note: Do not take any deductions for clearance. The manufacturer will take necessary deductions for a perfect fit. Measure each window individually as size variances are common. Record all measurements.

Light Gaps: On Continuous-loop and motorization inside mounts, there is approximately 1/16" light gap per side. On Cordless inside mounts, there is approximately 1" of light gap on right side and just over 1/2" on left side. For optimal light and glare control, outside mount is recommended, or you may add a secondary soft window treatment (drapery or curtain) to hide the light gap on an inside mount.

Outside Mount Window treatments are installed outside the window casing. Mount directly to wall or molding.

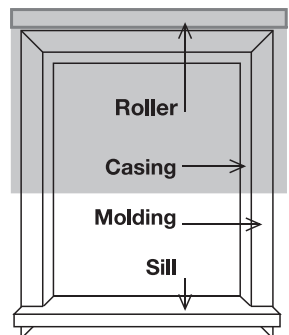

Outside Mount Blind

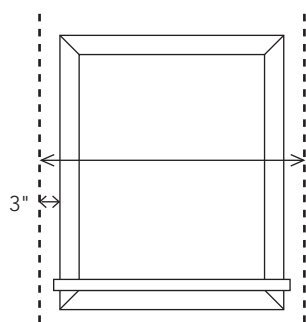

Width

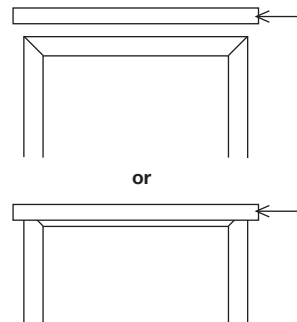

Roller Location

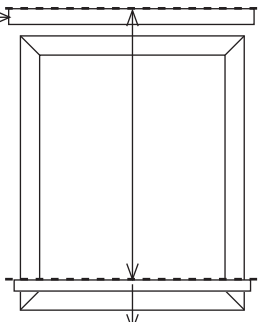

Height

- 1 **Measure Width:** Measure width to be covered. We recommend 3" overlap on each side of the window (6" total) for optimum light control and privacy. Record measurement.
- 2 **Determine Roller Location:** Determine if roller will be on molding or above molding and mark spot.
- 3 **Measure Height:** Measure height to be covered from top of roller location to top of sill or lower if overlap is desired for additional light control and privacy. Record measurement.

Note: The manufacturer makes NO deductions on outside-mount installations.

Mounting Considerations

Reason for Choosing Inside Mount

Clean Look

- Inside-mount treatments are installed inside the window casing, showcasing attractive window trim.
- The window opening frames the treatment for a finished, clean appearance.

Allows Sill Space on Deep Windows

- In some deep-set windows, the window treatment can be installed to allow plants or other items to be placed in front of the window treatment on the sill.

Limitations of Inside Mount

Light Gaps

- A small deduction in the width and/or length is taken at the manufacturer to allow for proper operating clearance, and this causes a large gap on each side of the treatment, affecting the treatment's ability to darken a room.

Obstructed View

- The stack (compressed portion of the window treatment when fully raised) will obstruct part of the view from the window.
- The amount of stack varies by product and control type.

Architectural Obstacles

- Obstacles such as handles and cranks can interfere with the operation of inside-mount treatments.

Reason for Choosing Outside Mount

Improve Privacy and Light Control

- Light gaps on the side of the window treatment can be substantially diminished or eliminated.

Fewer Installation Limitations

- Outside-mount window treatments are ideal for covering non-square windows.
- Outside-mount window treatments are installed higher than the window opening for an unobstructed view when fully raised.

Architectural Obstacles

- Outside-mount window treatments can clear obstacles like handles and cranks.

Enlarge the Look of a Small Window

- Increase overlap above and below or to each side of the window.

Hide Window Trim

- Outside-mount treatments can easily hide unattractive window trim.

Limitations of Outside Mount

Required Surface Above Window Frame

- Outside-mount brackets require at least 2" of flat surface above window or on window frame for mounting brackets. Free projection brackets can be ordered if needed to clear frame or molding.

Inside Mount Window Casing Minimum Depth Requirements

A. Flush Mount: If the window casing is deep enough to mount the entire shade inside of it, this is called a flush mount.

B. Partially Recessed: A partially recessed window treatment is where the depth of the window casing is less than the space necessary for a flush mount.

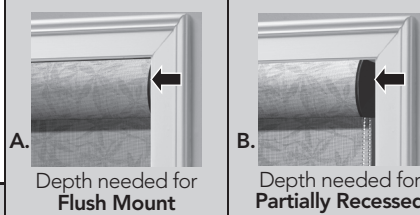

Roller & Solar Shades	Control Type	Depth needed for Flush Mount	Depth needed for Partially Recessed
No Valance	Continuous-loop/Motorized	4 1/8"	3/4"
	Cordless	2 1/2"	2"
Small Cassette Valance	Continuous-loop	3 3/8"	1 3/8"
	Cordless	3 1/2"	2"
Large Cassette Valance	Continuous-loop/Motorized	5 1/2"	1 3/4"
Square Corner Valance	Continuous-loop/Motorized	3 1/8"	1 3/8"
	Cordless		

Please call Customer Service at 1-800-538-9419 for additional assistance.