

# Graber® Measuring Guide for Horizontal Blinds

## Tools and Tips

- Steel tape measure — do not use cloth tape
- Pencil
- Measure each window and identify window locations — size variances are common
- Round measurements to the nearest 1/8"
- Clearly record measurements — width vs. height

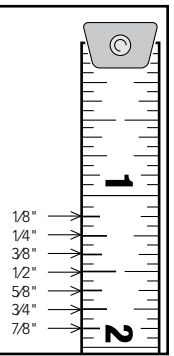

## Choose a Mount Type: Inside Mount or Outside Mount

(See next page if you need help deciding which mount is best for your windows.)

### Inside Mount Window treatments are installed inside the window casing.

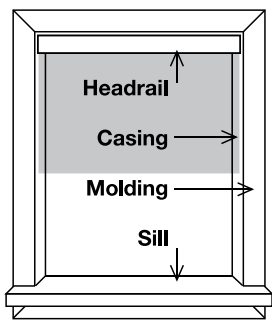

Inside Mount Blind

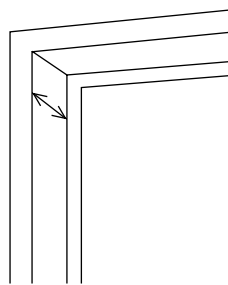

Depth

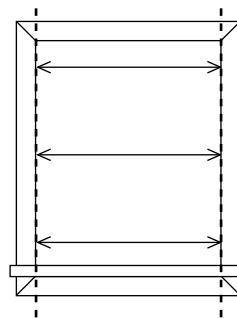

Width

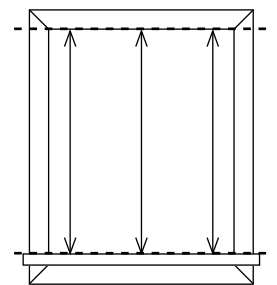

Height

- 1 **Measure Depth:** See chart on next page to determine if window casing has enough depth for an inside-mount window treatment.
- 2 **Measure Width:** Measure the inside width of window casing in three places. Record narrowest measurement.
- 3 **Measure Height:** Measure the inside height from the top of window casing to top of sill in three places. Record longest measurement.

**Note:** Do not take any deductions for clearance. The manufacturer will take necessary deductions for a perfect fit.

### Outside Mount Window treatments are installed outside the window casing. Mount directly to wall or molding.

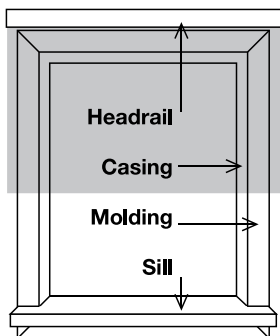

Outside Mount Blind

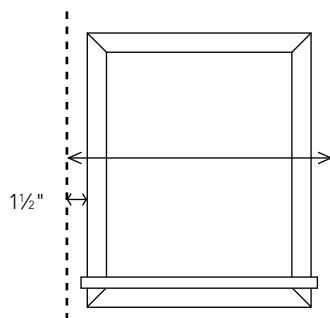

Width

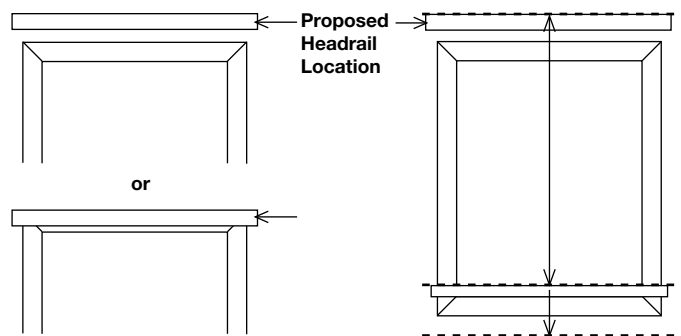

Headrail Location

Height

- 1 **Measure Width:** Measure width to be covered. We recommend 1/2" overlap on each side of the window (3" total) for optimum light control and privacy. Record measurement.
- 2 **Determine Headrail Location** Determine if headrail will be on molding or above molding and mark spot.
- 3 **Measure Height:** Measure height to be covered from top of headrail location to top of sill or lower if overlap is desired for additional light control and privacy. Record measurement.

**Note:** The manufacturer makes NO deductions on outside-mount installations.

# Mounting Considerations

## Reason for Choosing Inside Mount

### Clean Look

- Inside-mount treatments are installed inside the window casing, showcasing attractive window trim.
- The window opening frames the treatment for a finished, clean appearance.

### Allows Sill Space on Deep Windows

- In some deep-set windows, the window treatment can be installed to allow plants or other items to be placed in front of the window treatment on the sill.

## Limitations of Inside Mount

### Light Gaps

- A small deduction in the width and/or length is taken at the manufacturer to allow for proper operating clearance, and this causes a small gap on each side of the treatment, affecting the treatment's ability to darken a room.

### Obstructed View

- The stack (compressed portion of the window treatment when fully raised) will obstruct a part of the view from the window.
- The amount of stack varies by product.

### Architectural Obstacles

- Obstacles such as handles and cranks can interfere with the operation of inside-mount treatments.

## Reason for Choosing Outside Mount

### Improve Privacy and Light Control

- Light gaps on the side of the window treatment can be substantially diminished or eliminated.

### Fewer Installation Limitations

- Outside-mount window treatments are ideal for covering non-square windows.
- Outside-mount window treatments are installed higher than the window opening for an unobstructed view when fully raised.

### Architectural Obstacles

- Outside-mount window treatments can clear obstacles like handles and cranks.

### Enlarge the Look of a Small Window

- Increase overlap above and below or to each side of the window.

### Hide Window Trim

- Outside-mount treatments can easily hide unattractive window trim.

## Limitations of Outside Mount

### Required Surface Above Window Frame

- Outside-mount brackets require at least 2" of flat surface above window or on window frame for mounting brackets. Projection brackets can be ordered if needed to clear frame or molding.

## Inside Mount Window Casing Minimum Depth Requirements

**A. Flush Mount:** If the window casing is deep enough to mount the entire headrail inside of it, this is called a flush mount.

**B. Partially Recessed:** A partially recessed window treatment is when the depth of the window casing is less than the space necessary for a flush mount.

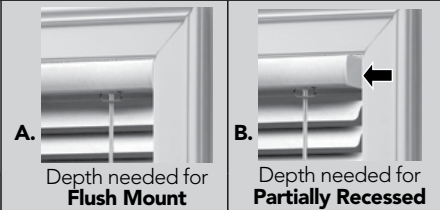

Horizontal Blinds	Depth needed for Flush Mount	Depth needed for Partially Recessed
1" Classics Supreme and 1" Classics Supreme Privacy Aluminum Blinds	1 ¾"	¾"
1" Classics Supreme and 1" Classics Supreme Privacy Cordless Aluminum Blinds	2 ½"	¾"

Headrail flush mount depth chart valid for flush-mount headrail on standard blinds only. Please call Customer Service at 1-800-538-9419 for additional assistance.